

DHT
スペアパーツ



TOYOTA



***Disc Brake Pads Identification
& Brake Shoes Identification***

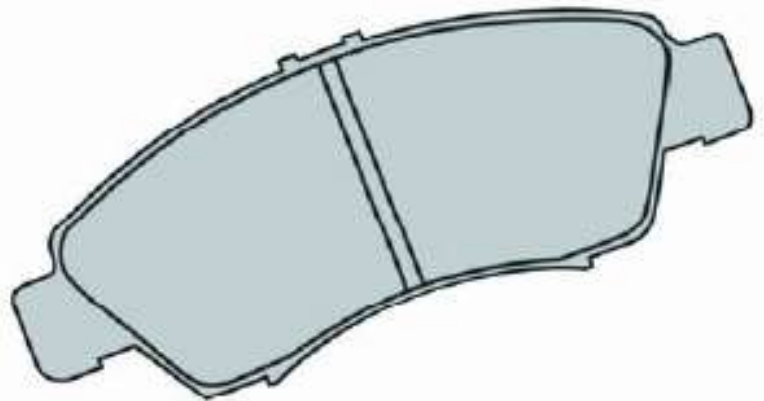
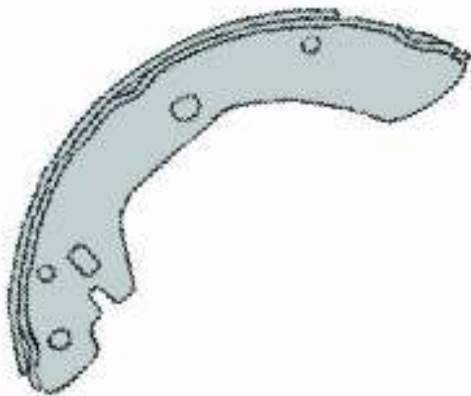

DHT1016-2 OE
0449187606

DAIHATSU

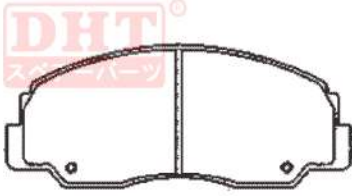

Front Axle
Brake System : AKB
Width : 127.8
Height : 52.3
Thickness : 14

DHT1016-2 OE
0449187606

DAIHATSU

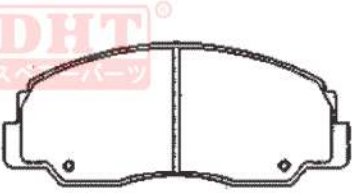

Front Axle
Brake System : AKB
Width : 127.8
Height : 52.3
Thickness : 14

DHT1108 OE
0449187503

DAIHATSU

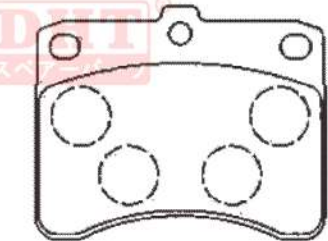

Front Axle
Brake System : SUM
Width : 78.8
Height : 63.4
Thickness : 13.5

DHT1202 OE
0449187101

DAIHATSU; 吉利汽车; 夏利(一汽)

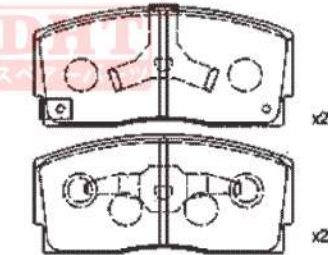

Front Axle
Brake System : SUM
Width : 102.7
Height : 47
Thickness : 14

DHT1016 OE
0449187613

DAIHATSU; ISUZU; MAZDA

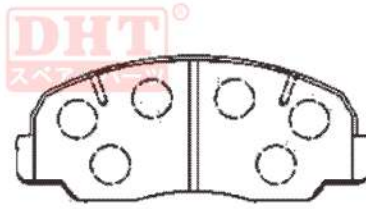

Front Axle
Brake System : AKB
Width : 127.7
Height : 52.2
Thickness : 14

DHT1070 OE
0449187720

DAIHATSU; 吉利汽车; 夏利(一汽); 哈飞

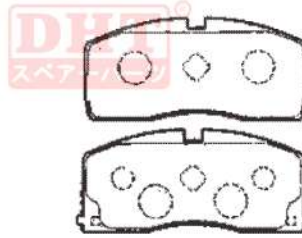

Front Axle
Brake System : SUM
Width : 102.8
Width 1 : 108
Height : 47
Thickness : 14

DHT1165 OE
044918750600

DAIHATSU

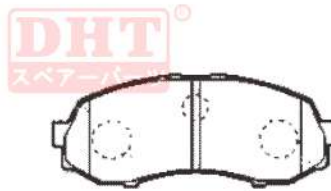

Front Axle
Brake System :
Width : 110
Height : 44
Thickness : 14.5

DHT1225 OE
D0YN3328Z

MAZDA; DAIHATSU; TOYOTA; FORD; 长安福特; SUBARU; 长安马自达FORD

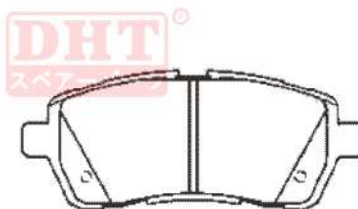

Front Axle
Brake System : Lucas
Width : 125.6 mm
Height : 51.48 mm
Thickness : 15.3 mm

DHT1379 OE
D6Y13328Z

MAZDA; DAIHATSU

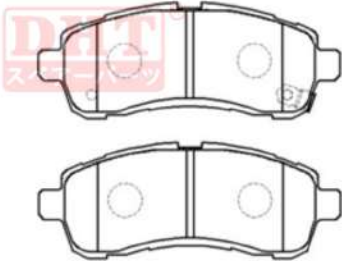

Front Axle
Brake System :
Width : 125.5
Height : 48.2
Thickness : 15.0

DHT1446 OE
0449187401

DAIHATSU; MITSUBISHI; DODGE; PLYMOUTH; EAGLE; 天津一汽丰田;
华利(一汽)

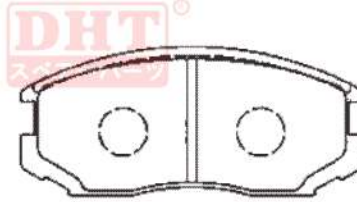

Front Axle
Brake System : SUM
Width : 114
Height : 49.9
Thickness : 15

DHT1236 OE
044660D010

TOYOTA; DAIHATSU

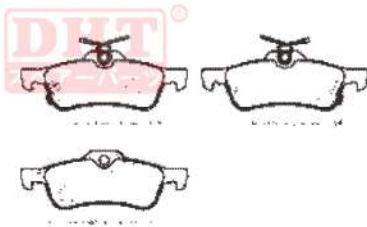

Rear Axle
Brake System : ATE
Width : 123 mm
Height : 43.7 mm
Thickness : 15 mm

DHT1456 OE
0449112141

MAZDA; TOYOTA; DAIHATSU; HONDA; Hyundai; MITSUBISHI

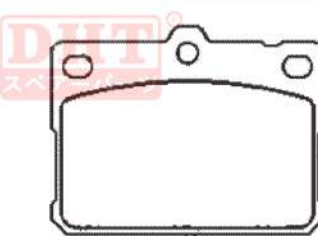

Front Axle
Brake System : SUM
Width : 78.5
Height : 59.6
Thickness : 14.5

DHT1235 OE
0449197217

SUZUKI; DAIHATSU

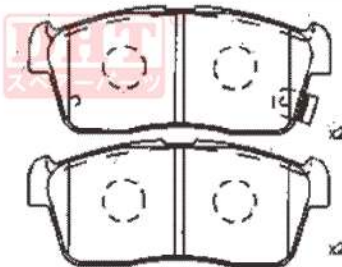

Front Axle
Brake System : AKB
Width : 108.4
Height : 45.35
Thickness : 15

DHT1227 MYNO
HR1227

DAIHATSU

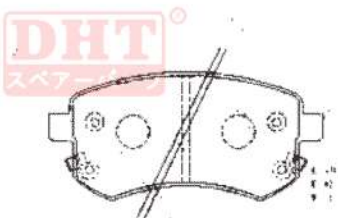

Brake System :
Width : 131.4
Height : 62
Thickness : 15

DHT1359 OE
044918750700

TOYOTA; DAIHATSU

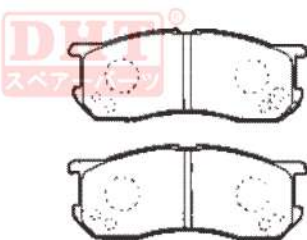

Front Axle
Brake System :
Width : 106
Height : 41.5
Thickness : 15

DHT1269 OE
0446528360

TOYOTA; DAIHATSU

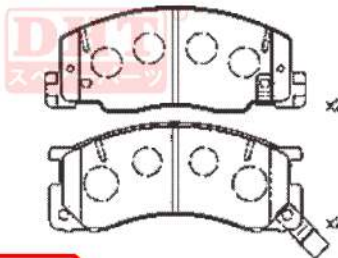

Front Axle
Brake System : AKB
Width : 128
Width 1 : 137.5
Height : 51.4
Height 1 : 55.5
Thickness : 15.5

DHT1697 OE
0449197201

DAIHATSU; 华利(一汽)

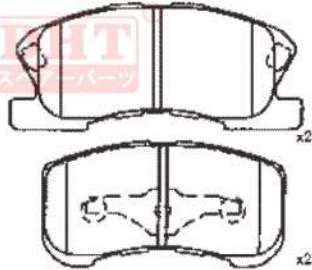

Front Axle
Brake System : AKB
Width : 95
Width 1 : 115.4
Height : 49.5
Thickness : 15.5

DHT1466 OE
0449197202

DAIHATSU

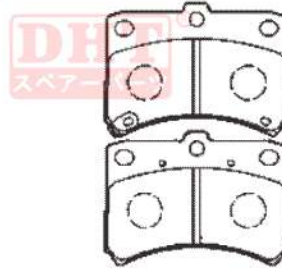

Front Axle
Brake System : SUM
Width : 78.8
Height : 58
Thickness : 14.5

DHT1696 OE
0449197203

DAIHATSU; TOYOTA; MITSUBISHI

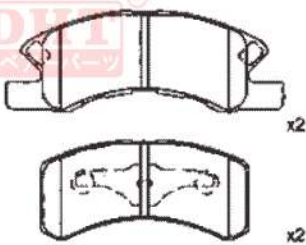

Front Axle
Brake System : AKB
Width : 91.9
Width 1 : 121.8
Height : 44.3
Thickness : 15.3

DHT1493 OE
0446633090

TOYOTA; LEXUS; CHERY; DAIHATSU

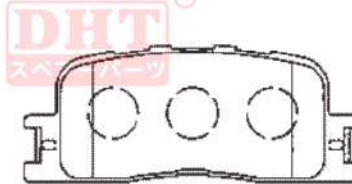

Rear Axle
Brake System : AKB
Width : 93
Height : 38
Thickness : 15.8

DHT1666 OE
04491972100C

TOYOTA; DAIHATSU; SUBARU

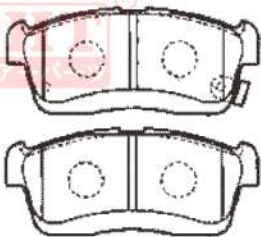

Front Axle
Brake System : HITACHI
Width : 108.7
Height : 45.5
Thickness : 14.5

DHT1616 OE
04465BZ010

TOYOTA; DAIHATSU; 一汽吉林大发; SUZUKI

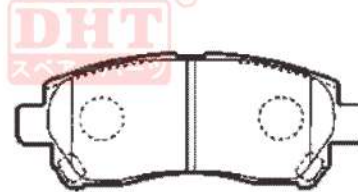

Front Axle
Brake System :
Width : 127
Height : 49.5
Thickness : 14.5

DHT1698 OE
044918721600

DAIHATSU

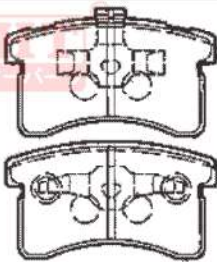

Front Axle
Brake System : AKB
Width : 88.4
Height : 49.2
Thickness : 14

DHT1467 OE
0449187700

DAIHATSU

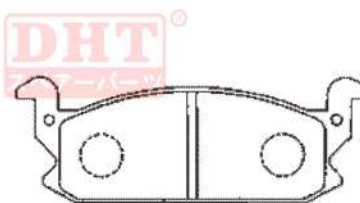

Front Axle
Brake System : AKB
Width : 124.1
Height : 43.6
Thickness : 14

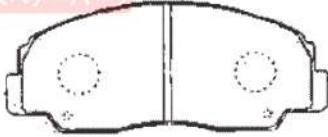
DHT1730	OE 0449187612
DAIHATSU	
	Front Axle Brake System : AKB Width : 127.6 Height : 52.8 Thickness : 13.8

DHTK0034	OE 044958770400
DAIHATSU; 吉利汽车; 夏利(一汽)	
	Rear Axle Brake System : SUMITOMO Diameter : 180 mm Width : 28 mm

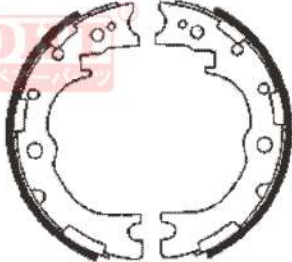
DHTK0015	OE 4653025010
TOYOTA; DAIHATSU	
	Rear Axle Diameter : 178 mm Width : 35 mm

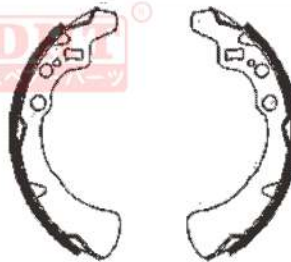
DHTK0021	OE 474308720500
DAIHATSU	
	Rear Axle Brake System : AKEBONO Diameter : 180 mm Width : 35 mm

DHTK0016	OE 044948730700
DAIHATSU	
	Front Axle ; Rear Axle Diameter : 320 mm Width : 75 mm

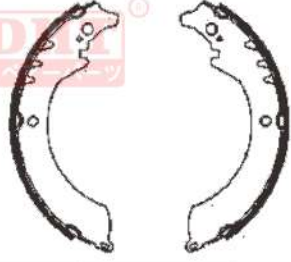
DHTK0022	OE 044958760100
DAIHATSU; TOYOTA; FIAT	
	Rear Axle Brake System : AKEBONO Diameter : 254 mm Width : 45 mm

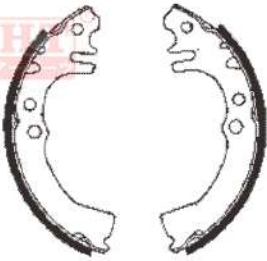
DHTK0024	OE 044958720400
DAIHATSU	
	Rear Axle Diameter : 165mm Width : 28 mm

DHTK0031	OE K0031
DAIHATSU	
	Rear Axle Diameter : 228.6 mm Width : 35 mm

DHTK2239 OE
0449425011

DAIHATSU



Front Axle
Diameter : 290 mm
Width : 60 mm

DHTK2252 OE
0449530070

TOYOTA; DAIHATSU

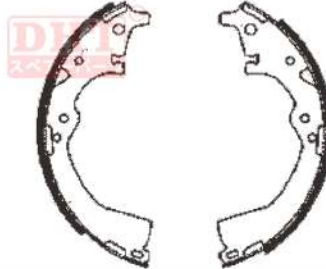

Rear Axle
Brake System : AKEBONO
Diameter : 254 mm
Width : 50 mm

DHTK0038 OE
474309750300

DAIHATSU

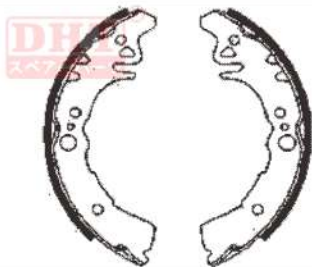

Rear Axle
Diameter : 180mm
Width : 35 mm

DHTK0029 OE
474208750100

DAIHATSU

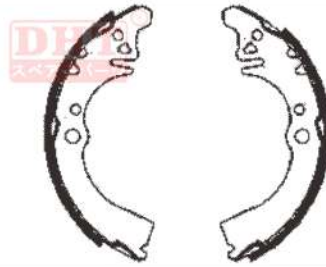

Rear Axle
Brake System : SUMITOMO
Diameter : 180 mm
Width : 38 mm

DHTK0032 OE
GS8456

DAIHATSU; SUZUKI; SUBARU; MAZDA; GEO; 铃木(昌河)

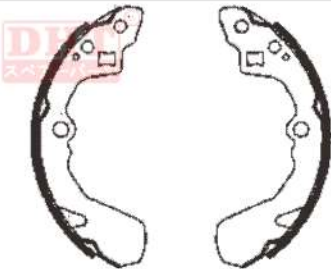

Rear Axle
Brake System : SUMITOMO
Diameter : 200 mm
Width : 32 mm

DHTK0037 OE
044959721300

DAIHATSU; TOYOTA

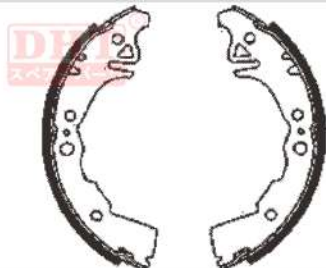

Rear Axle
Diameter : 180 mm
Width : 38 mm

DHTK2210 OE
0449420011

TOYOTA; DAIHATSU



Rear Axle
Diameter : 228.6 mm
Width : 40 mm

DHTK2232 OE
0449514010

TOYOTA; DAIHATSU

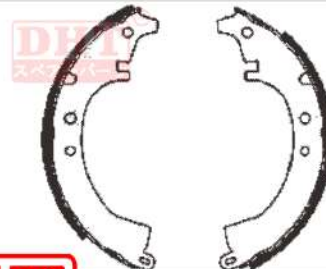

Rear Axle
Brake System : AKEBONO
Diameter : 228.6 mm
Width : 42 mm